



---

# Measurement of sea salt aerosol in Gibraltar

Quantification of the contribution of sea salt to the total airborne ambient PM<sub>10</sub> mass concentration

---

**Report for the Gibraltar Environmental Agency**

Unrestricted  
AEAT/ENV/R/3326  
ED56291  
Issue Number 1  
Date 13/09/2012



Government of Gibraltar

**Gibraltar  
Environmental  
Agency**



**Customer:**

Gibraltar Environmental Agency

**Contact:**

Steve Telling  
AEA Technology plc  
Gemini Building, Harwell, Didcot, OX11 0QR  
t: 0870 190 6583  
f: 0870 190 4850

**Confidentiality, copyright & reproduction:**

© Copyright AEA Technology plc  
This report is the Copyright of Gibraltar Environmental Agency / AEA Technology plc and has been prepared by AEA Technology plc under contract to Gibraltar Environment Agency dated 20/01/2011. The contents of this report may not be reproduced in whole or in part, nor passed to any organisation or person without the specific prior written permission of Gibraltar Environmental Agency / AEA Technology plc. AEA Technology plc accepts no liability whatsoever to any third party for any loss or damage arising from any interpretation or use of the information contained in this report, or reliance on any views expressed therein.

e: Steve.Telling@aeat.co.uk

AEA is a business name of AEA Technology plc  
AEA is certificated to ISO9001 and ISO14001

**Author:**

Justin Lingard

**Approved By:**

Steve Telling

**Date:**

13 September 2012

**Signed:****AEA reference:**

ID: AEAT/ENV/R/3326

Ref: ED56291- Issue Number 1

G:\Gibraltar\_policy\Gibraltar2011\natural\_correction\_2011\seasalt\Quantification of the contribution of the sea salt\_final.docx

## Executive summary

This Report summarises the two measurement methods, in current use, in Gibraltar to determine the contribution of the sea salt to the total ambient airborne particulate matter ( $PM_x$ ) and  $PM_{10}$  mass concentrations. The report summarises the first year's results for the calendar year 2011.

Particular attention is given to the determination of the contribution of sea salt to the  $PM_x$  and  $PM_{10}$  mass concentrations, termed the  $PM_x$  and  $PM_{10}$  sea salt mass fractions, measured at the Rosia Road air quality monitoring station. Daily mean  $PM_{10}$  mass concentration measurements from Rosia Road are reported annually to European Commission in order to demonstrate compliance with the daily mean and annual mean  $PM_{10}$  Limit Values imposed under the European Air Quality Directive. The daily  $PM_{10}$  sea salt mass fraction measurements from the Partisol sampler located at the Rosia Road air quality monitoring station are used for the natural sources correction for compliance reporting, in accordance with the Guidance issued by the Commission.

### **Box 1: 2011 summary.**

- Measurements from the DELTA sampler showed that the monthly mean  $PM_x$  sea salt mass fraction ranged from 4-10  $\mu\text{g m}^{-3}$  and 4-20  $\mu\text{g m}^{-3}$  at the Rosia Road and Bleak House air quality monitoring stations, respectively.
- The monthly mean  $PM_x$  sea salt mass fraction measured from the two air quality monitoring stations showed that the sea salt mass concentrations measured at Bleak House were almost twice those measured at Rosia Road. This is to be expected as the air quality monitoring station at Bleak House is generally more exposed than that at Rosia Road.
- The 2011 daily measurements of the  $PM_{10}$  sea salt mass fraction ranged from less than 1 to 16  $\mu\text{g m}^{-3}$ . The annual mean sea salt mass concentration was 3  $\mu\text{g m}^{-3}$ . This value corresponds well with previous Spanish research undertaken in La Línea de la Concepción.
- Comparison of DELTA measurements of the monthly mean  $PM_x$  sea salt mass fraction measured at the Rosia Road air quality monitoring station to the corresponding monthly mean  $PM_{10}$  sea salt mass fraction measurements showed that they were twice as great.
- This result is believed to indicate that the DELTA sampler samples airborne (sea salt) particles greater than 10  $\mu\text{m}$  in diameter. If the DELTA monthly mean  $PM_x$  sea salt mass fraction measurements were to be used as a proxy measure of the monthly mean  $PM_{10}$  sea salt mass fraction at the Rosia Road air quality monitoring station for compliance reporting, they would require correcting for this effect.

## Table of contents

<b>1</b>	<b>Introduction .....</b>	<b>1</b>
1.1	Origin of sea salt aerosol.....	1
1.2	Influence of meteorology on sea salt aerosol production .....	1
1.3	Policy Context.....	2
<b>2</b>	<b>DELTA sampler .....</b>	<b>4</b>
2.1	Overview of the DELTA sampler .....	4
2.2	Method.....	4
2.3	Features of the DELTA sampler.....	7
2.4	Determination the $PM_x$ sea salt mass fraction.....	7
<b>3</b>	<b>Partisol sampler .....</b>	<b>8</b>
<b>4</b>	<b>Results.....</b>	<b>10</b>
4.1	Calculation of the monthly mean $PM_x$ and daily mean $PM_{10}$ sea salt mass fraction .....	10
4.2	2011 measurement summary.....	11

# 1 Introduction

## 1.1 Origin of sea salt aerosol

Sea salt aerosol contributes significantly to the total airborne ambient particulate matter ( $PM_x$ ) and  $PM_{10}$  mass concentrations measured in coastal areas. Sea salt aerosol is produced at the ocean surface by the bursting of air bubbles formed from the entrainment of air induced by wind stress<sup>1</sup>. Sea salt aerosol can be characterised on the basis of its origin<sup>2</sup>:

- 1) Primary sea salt: composed primarily of freshly generated sea salt, including a small fraction of primary organic sulphur, and
- 2) Secondary sea salt: produced by gas-to-particle conversion, consisting mainly of non-sea-salt sulphate and organic matter.

It is widely reported<sup>1,3,4,5</sup> that an exponential relationship exists between the wind speed and the  $PM_x$  and  $PM_{10}$  sea salt mass concentration. Considerable variation exists in the reported relationships due to differences in measurement instrumentation, altitude, distance, and prevailing meteorology<sup>1,3,4,5,6,7</sup>. Simply put, this means that the contribution of sea salt to the  $PM_x$  and  $PM_{10}$  mass concentrations, hereafter termed the  $PM_x$  and  $PM_{10}$  sea salt mass fractions, will tend to be greater at seaside and near-coastal air quality monitoring stations, when compared to measurements from inland air quality monitoring stations. Mass concentrations will be greater under high wind speed conditions when compared to measurements made at low wind speed, increasing by approximately 2.5 times for every  $1 \text{ m s}^{-1}$  increase in wind speed. Other factors affecting the sea salt aerosol production rate include wind speed history, fetch and air/sea temperature difference<sup>6</sup>.

Gibraltar is a peninsula and therefore the impact of sea salt on the  $PM_{10}$  mass concentration is likely to be significant under certain meteorological conditions. Synoptic scale meteorological events (e.g., over a horizontal scale of 1000 km) and sea state contribute to the generation of sea spray and therefore the contribution of sea salt to the  $PM_{10}$  mass concentration in Gibraltar.

## 1.2 Influence of meteorology on sea salt aerosol production

As noted in the previous Section sea salt aerosol production over the open-ocean is principally wind-driven. It is important to note that due to the temperate climate within the mid-latitudes, in which Gibraltar is situated, that the sea salt the source strength, i.e., its

<sup>1</sup> O'Dowd, C.D., Smith, M.H. Consterdine, I.E. and Lowe, J.A.: Marine aerosol, sea-salt, and the marine sulphur cycle: a short review. *Atmospheric Environment*, 31(1), 73-80, doi: 10.1016/S1352-2310(96)00106-9, 1997.

<sup>2</sup> Council of the European Union: Commission staff working paper establishing guidelines for demonstration and subtraction of exceedances attributable to natural sources under the Directive 2008/50/EC on ambient air quality and cleaner air for Europe. SEC(2011) 208 final, 2011, [http://ec.europa.eu/environment/air/quality/legislation/pdf/sec\\_2011\\_0208.pdf](http://ec.europa.eu/environment/air/quality/legislation/pdf/sec_2011_0208.pdf).

<sup>3</sup> Fitzgerald, J.W.: Marine aerosols: A review. *Atmospheric Environment Part A. General Topics*, 25(3-4), 533-545, doi: 10.1016/0960-1686(91)90050-H, 1991.

<sup>4</sup> Gong, S.L., Bartie, L.A., and Blanchet, J.-P.: Modeling sea-salt aerosols in the atmosphere. 1. Model development. *Journal of Geophysical Science*, 102(D3), 3805-3818, 1997.

<sup>5</sup> Lewis, E.R. and Schwartz, S.E.: Sea salt aerosol production: mechanisms, methods, measurements, and models a critical review. *Geophysical Monograph Series*, 152, 2005.

<sup>6</sup> Wai, K.-M. and Tanner, P.A.: Wind-dependent SS aerosol in a Western Pacific coastal area. *Atmospheric Environment*, 38(8), 1167-1171, doi: 10.1016/j.atmosenv.2003.11.007, 2004.

<sup>7</sup> Querol, X., Alastuey, A., Moreno, T., Viana, M.M., Castillo, S., Pey, J., Rodríguez, S., Artiñano, B., Salvador, P., Sánchez, M., Garcia Dos Santos, S., Herce Garraleta, M.D., Fernandez-Patier, R., Moreno-Grau, S., Negral, L., Minguillón, M.C., Monfort, E., Sanz, M.J., Palomo-Marín, J., Pinilla-Gil, E., Cuevas, E., de la Rosa, J. and Sánchez de la Campa, A.: Spatial and temporal variations in airborne particulate matter ( $PM_{10}$  and  $PM_{2.5}$ ) across Spain 1999-2005. *Atmospheric Environment*, 42(17), 3964-3979, doi: 10.1016/j.atmosenv.2006.10.071, 2008.

production rate, from open-water will be relatively diminished in the summer months when compared to winter.

Generally speaking summer months within the mid-latitudes are characterised by high pressure systems that bring stable, warm weather conditions. By comparison, weather conditions in winter in the mid-latitudes are dominated by cyclonic weather conditions that bring storms eastwards over the Atlantic towards Western Europe. Storm fronts are commonly characterised by low pressure systems, high wind speeds and increased rates of precipitation. High wind speeds increase the shear stress at the interface of the lower atmosphere and water surface. The mechanical action of the wind leads to tearing of wave crests, termed “white capping”, which leads to the production of seawater and spume droplets. Once emitted into the atmosphere, the liquid meniscus of the seawater droplet evaporates, leaving sea salt aerosol<sup>1,3,4,5</sup>. Precipitation further acts to agitate the upper surface of the oceans, thereby contributing to seawater droplet production at the upper water surface-lower atmosphere boundary, but only on an intermittent and local scale<sup>4</sup>. Precipitation can wash-out sea salt aerosol from the atmosphere, thereby providing a loss mechanism for sea salt aerosol.

Although sea salt aerosol production rates over the open-ocean are notably lower in summer months than in winter months due to the prevailing stable meteorology, it is important to note that on-shore sea breezes tend to be more prevalent in the summer months<sup>7</sup>. On-shore sea breezes act to transport sea salt aerosol from the water’s surface to the coast. Therefore in reality the PM<sub>x</sub> and PM<sub>10</sub> sea salt mass fractions measured at coastal air quality monitoring stations may diminish little in the summer months.

### 1.3 Policy Context

European Directive 1999/30/EC<sup>8</sup> specified that Member States were obliged to implement action plans where the Limit Values (LVs) for PM<sub>10</sub> and other ambient air pollutants, namely sulphur dioxide (SO<sub>2</sub>), nitrogen dioxide (NO<sub>2</sub>) and oxides of nitrogen (NO<sub>x</sub>), and lead, are exceeded due to causes other than natural events. In July 2010 the European Air Quality Directive (AQD)<sup>9</sup> came into force and further guidance was provided by the Commission for assessing and reporting of air pollutant concentrations where natural sources contribute to the exceedence of the specified LVs. The AQD specifies LVs for PM<sub>10</sub> for the protection of human health, which came into force from 01/01/2005:

- An annual mean concentration of 40 µg m<sup>-3</sup>, and
- A 24-hour (daily) mean concentration of 50 µg m<sup>-3</sup>, with 35 permitted exceedances each year.

Member States are required to inform the Commission in instances where natural events result in measured air pollutant concentrations that are significantly in excess of typical background concentrations. In the case of PM<sub>x</sub> and PM<sub>10</sub>, natural events can include: volcanic emissions, sea salt, and wind-blown dust. Member States are expected to provide justification to demonstrate that the measured exceedances were due to natural events. The mechanism for reporting concentrations to the Commission is the Annual Reporting Questionnaire which includes specific forms to report contributions from natural sources and corrected PM<sub>10</sub> concentrations, adjusted for this natural component. The Reporting Questionnaire is submitted to the Commission to demonstrate compliance with the daily mean and annual mean PM<sub>10</sub> LVs imposed under the AQD.

Guidance<sup>2</sup> issued by the European Commission on the quantification of the contribution of natural sources, including sea salt, to the daily mean PM<sub>10</sub> mass concentration states that due to the episodic nature of sea salt emissions, accurate daily quantification is required in order to apply a correction to the daily mean PM<sub>10</sub> mass concentration. Furthermore,

<sup>8</sup> Directive 1999/30/EC (the first Daughter Directive): Article 5, section 4.

<sup>9</sup> Directive 2008/50/EC (CAFE Directive), <http://eur-lex.europa.eu/LexUriServ/LexUriServ.do?uri=CELEX:32008L0050:EN:NOT>.

accounting for the daily mean  $PM_{10}$  sea salt mass fraction reported in the Questionnaire requires that it is determined at each site reported. In the case of Gibraltar, daily and annual mean  $PM_{10}$  mass concentration measurements from the Rosia Road air quality monitoring station are reported in the Annual Reporting Questionnaire. Therefore it is necessary to quantify the daily mean  $PM_{10}$  sea salt mass fraction at this site for the purposes of making a correction to the measured daily mean  $PM_{10}$  mass concentration reported in the Questionnaire.

Prior to 2011 no formal quantification of the daily mean  $PM_{10}$  sea salt mass fraction had been attempted in Gibraltar. Previous Spanish research undertaken in La Línea de la Concepción indicated that sea salt accounted for ~10% of the total  $PM_{10}$  mass concentration<sup>7</sup>. In order to better quantify the contribution of sea salt during 2011, to the daily mean  $PM_{10}$  mass concentration in Gibraltar, measurements were undertaken using two different approaches:

- a) Monthly measurements of the  $PM_x$  sea salt mass fraction using a DELTA sampler located at the Rosia Road and Bleak House air quality monitoring stations, and
- b) Daily measurements of the  $PM_{10}$  sea salt mass fraction using a dedicated Partisol  $PM_{10}$  sampler located at the Rosia Road air quality monitoring station.

Sections 2 and 3 describe the 2011 monthly and daily measurements of the  $PM_{10}$  sea salt mass fraction undertaken in Gibraltar, respectively. Section 4 summarises the results of the 2011 measurements. It is anticipated that this dual measurement approach will be maintained in future years.

## 2 DELTA sampler

### 2.1 Overview of the DELTA sampler

Monthly measurements of the  $PM_x$  sea salt mass fraction commenced simultaneously on 1<sup>st</sup> September 2010 at the Rosia Road and Bleak House air quality monitoring stations. These measurements preceded the daily  $PM_{10}$  sea salt mass fraction measurements from the Partisol sampler located at the Rosia Road air quality monitoring station described in the next Section, which did not commence until 8<sup>th</sup> April 2011.

The DELTA sampler provides a low-cost solution for quantifying the monthly mean  $PM_x$  sea salt mass fraction. These measurements were maintained as they provide a measure of the monthly mean  $PM_x$  sea salt mass fraction at the two air quality monitoring stations in Gibraltar: Rosia Road and Bleak House. This approach permits examination of the inter-relationship of the monthly mean  $PM_x$  sea salt mass fraction at the two stations. Furthermore, continuation of these measurements provides a degree of contingency: determination of the relationship between the monthly mean  $PM_x$  sea salt mass fraction, measured by the DELTA sampler, and the monthly mean of the daily mean  $PM_{10}$  sea salt mass fraction, measured by the Partisol sampler, would permit the measurements from the DELTA sampler to be used to provide a proxy measure of the  $PM_{10}$  sea salt mass fraction for compliance assessment purposes should there be a fault with the Partisol sampler.

The DELTA sampler is composed of two discrete sections:

- 1) Diffusion denuders for sampling of acid ( $HNO_3$ ,  $HONO$ ,  $HCl$ ,  $SO_2$ ) and alkaline gases ( $NH_3^+$ ,  $NH_4^{2+}$ ), and
- 2) Aerosol-filter pack, allowing for determination of acid ( $NO_3^-$ ,  $NO_2^-$ ,  $Cl^-$ ,  $SO_4^{2-}$ ) and alkaline ( $Ca^{2+}$ ,  $K^+$ ,  $Na^+$ ,  $NH_4^{2+}$ ,  $Mg^{2+}$ ) components of  $PM_x$ <sup>10,11</sup>.

The sampling system was originally developed by the UK Centre for Ecology and Hydrology (CEH, Penicuik) for long-term sampling of ammonia and ammonium<sup>12</sup>. Due to the low-cost, robust nature and low power consumption, this system can be deployed in a wide-range of locations, including more remote location where there is limited mains power. In the UK the DELTA denuders are employed as part of Defra's [UK Acid Gases and Aerosols Monitoring Network \(AGANet\)](#), a component network of the [UK Eutrophying and Acidifying atmospheric Pollutants \(UKEAP\)](#) monitoring network, at thirty, rural sites nationwide. The chloride ( $Cl^-$ ) measurements from the AGANet are used to produce an annual sea salt mass concentration field for the UK. These measurements are used to correct the modelled background annual mean  $PM_{10}$  mass concentration in the UK which is reported annually to European Commission in order to demonstrate compliance with the annual mean  $PM_{10}$  Limit Value imposed under the European Air Quality Directive.

### 2.2 Method

The DELTA system is based around the concept of a single bore glass denuder for sampling trace gases and a filter pack for sampling atmospheric particles. The separation of  $PM_x$  from gaseous components is achieved due to the much more rapid diffusion of gaseous species to the tube wall compared with that of particles. Detailed descriptions of the DELTA denuder

<sup>10</sup> Sutton, M.A., Tang, Y.S., Miners, B., and Fowler, D: A new diffusion denuder system for long term, regional monitoring of atmospheric ammonia and ammonium, *Water, Air and Soil Pollution Focus*, 1(5/6), 145-156, doi: 10.1023/A:1013138601753, 2001.

<sup>11</sup> Tang, Y.S., van Dijk, N., Anderson, M., Simmons, I., Smith, R.I., Armas-Sanchez, E., Lawrence, H., and Sutton, M.A.: Monitoring of nitric acid, particulate nitrate and other species in the UK - 2007. Interim report under the UK Acid Deposition Monitoring Network to NETCEN/DEFRA, 2008.

<sup>12</sup> Fern, M.: Method for determination of atmospheric ammonia, *Atmospheric Environment*, 13(10), 1385-1393, doi: 10.1016/0004-6981(79)90107-0, 1979.



sampler can be found elsewhere<sup>10,13,14</sup>. Briefly, the sampling train consists of 2 x 15 cm (length)  $K_2CO_3$  + glycerol-coated (base coated) borosilicate glass denuders (normally used for the determination of acid gases:  $HNO_3$ ,  $SO_2$ , and  $HCl$ ) and 2 x 10 cm (length) phosphorous acid-coated ( $H_3PO_4$ ) denuders (normally used for the determination of base gases:  $NH_3$ ). The aerosol filter pack consists of carbonate-coated (for the determination of  $NO_3^-$ ,  $SO_4^{2-}$ ,  $Cl^-$ ,  $Na^+$ ,  $Ca^{2+}$ , and  $Mg^{2+}$ ) and acid-coated filter (normally used for the determination of  $NH_4^+$ ). The filters were 25 mm circles, hand-cut from 55 mm Fisher QT 200 cellulose circles (equivalent to Whatman No. 40).

Monthly measurements typically run from the first day of the month to the last day of the month. A piston air pump draws a laminar air flow (0.2-0.4 LPM) down the glass through the coated glass tubes which form the denuder section of the sample system. The monthly air sampling flow rate is 0.2 LPM. Data are set to fail the QC standard where the monthly air sampling flow rate fell below 0.2 LPM. Significant changes in the monthly air sampling flow rates are investigated promptly with the local site operator (LSO). A high sensitivity dry gas meter is used to determine the volume of sampled air.  $PM_x$  passes through the glass tubes unsampled and is sampled by an aerosol filter pack placed downstream of the denuder. Figure 2.1 shows the DELTA sampling train.

**Figure 2.1 DELTA sampling train.**

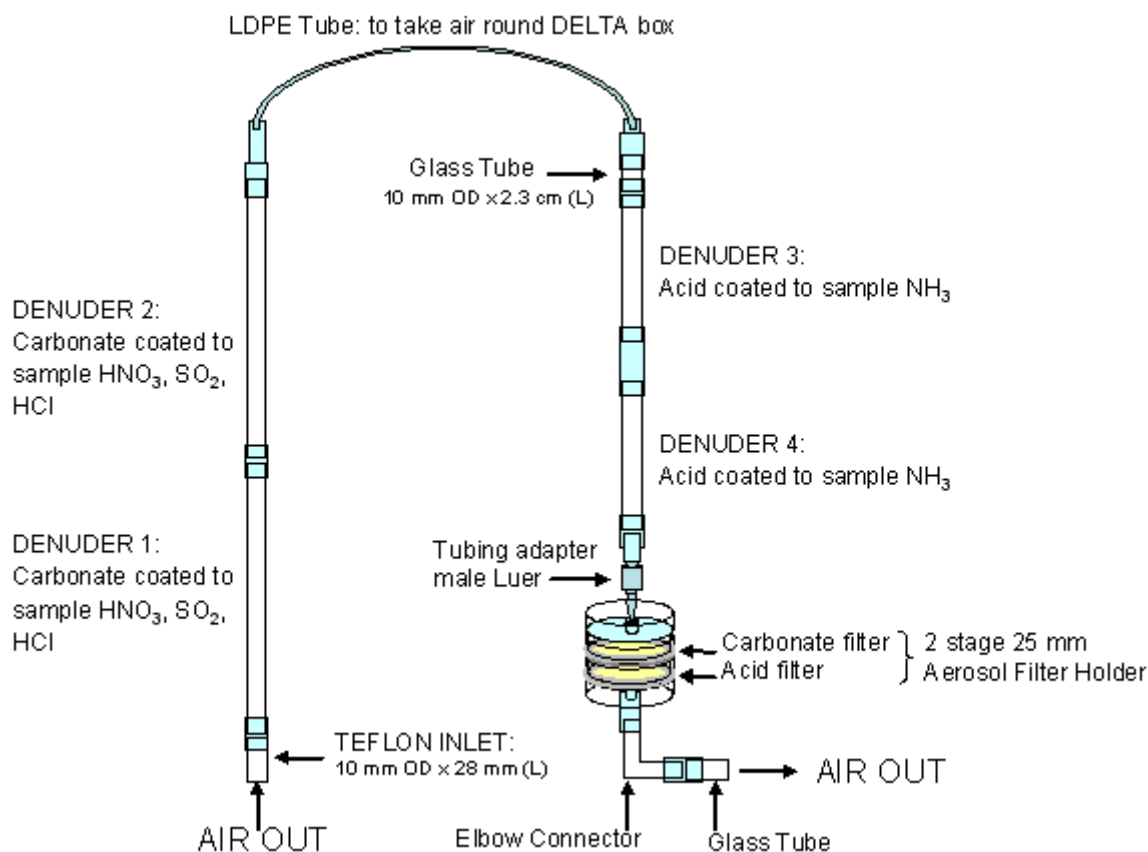

The section of LDPE tubing shown in Figure 2.1 has been removed from the system deployed in Gibraltar as the curvature of the tubing represented an aerosol loss mechanism. The system deployed in Gibraltar consists of the four-coated glass denuder sections

<sup>13</sup> Sutton, M.A., Miners, B., Tang, Y.S., Milford, C., Wyers, G.P., Duyzer, J.H., and Fowler, D.: Comparison of low cost measurement techniques for long-term monitoring of atmospheric ammonia, *Journal of Environmental Monitoring*, 446-453, doi: 10.1039/B102303A, 2001.

<sup>14</sup> Tang, Y.S., Simmons, I., van Dijk, N., di Marco, C., Nemitz, E., Dämmgen, U., Gilke, K., Djuricic, V., Vidic, S., Gliha, Z., Borovecki, D., Mitosinkova, M., Hanssen, J. E., Uggerud, T.H., Sanz, M.J., Sanz, p., Chorda, J.V., Flechard, C.R., Fauvel, Y., Ferm, M., Perrino, C., and Sutton, M.A.: European scale application of atmospheric reactive nitrogen measurements in a low-cost approach to infer dry deposition fluxes, *Agriculture, Ecosystems and Environment*, 133(3-4), 183-195, doi: 10.1016/j.agee.2009.04.027, 2009.

connected in series. The aerosol filter pack remains connected to the exhaust of the fourth section as shown in Figure 2.1.

Figure 2.2 shows the DELTA samplers in-situ at the Bleak House and Rosia Road air quality monitoring stations. The sample train is housed in a plastic sheath which attaches to the external walls of the air quality monitoring stations. The pump and gas flow meter are housed inside the air quality monitoring station enclosures. The ingress of water into the denuder sample train is prevented by the use of modified, inverted filter funnels connected to the outer plastic assembly which act as rain hats and to channel the sampled air.

**Figure 2.2 DELTA sampler in-situ at the (a) Bleak House and (b) Rosia Road air quality monitoring stations.**

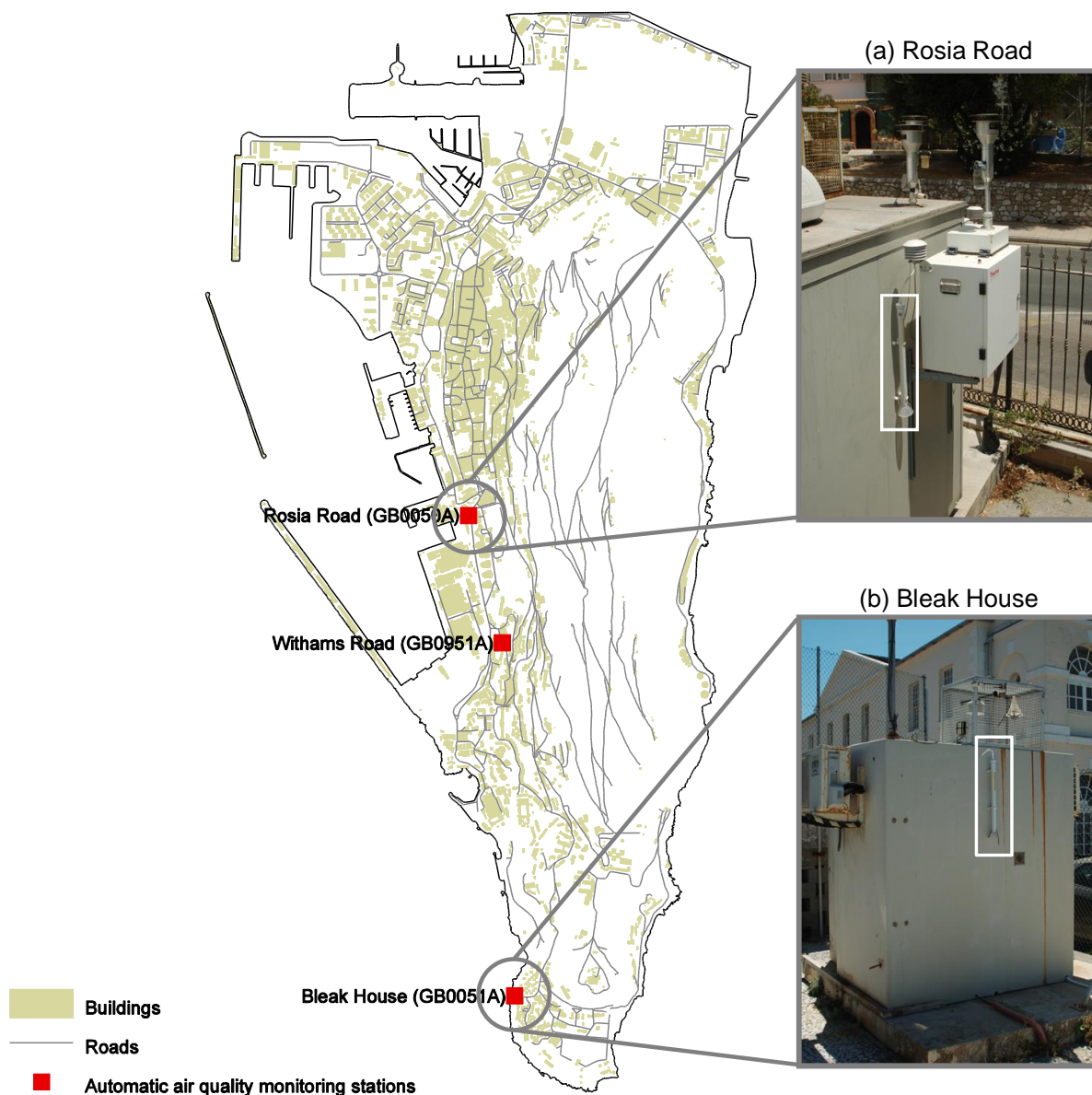

The DELTA samplers are made-up and assembled by a dedicated technician following the protocol provided by CEH. Each sampling site receives two DELTA samplers: one complete system which acts as a combined laboratory/field/transport blank and another which is used for sampling. Following exposure in the field, the blank and exposed DELTA samplers are returned to the laboratory. In the laboratory the Tissuquartz filters are extracted from the aerosol filter holders. The water soluble components of the sampled  $PM_x$ , including sea salt, were extracted from the sample filters by washing with 10 cm<sup>3</sup> deionised water. Ion chromatography is used to determine the chloride (Cl<sup>-</sup>) and sodium (Na<sup>+</sup>) ion concentration of

the extracts. The mass concentration ( $\mu\text{g m}^{-3}$ ) of the chloride and sodium ions in the sampled  $\text{PM}_{10}$  was calculated as described in Equation (1) (see Section 2.4). The monthly mean  $\text{PM}_x$  sea salt mass fraction was inferred following the method outlined in Section 4. Possible sample contamination is identified by extraction and analysis of the combined blank and subtracted from the samples.

## 2.3 Features of the DELTA sampler

One of the advantages of the DELTA sampler is that positive and negative sampling artefacts, such as the reactions between acid and alkaline gases and  $\text{PM}_x$  components, including sea salt, are limited. The heterogeneous reaction of acid gases, e.g., nitric acid ( $\text{HNO}_3$ ) and sulphuric acid ( $\text{H}_2\text{SO}_4$ ) with sea salt leads to the displacement of chloride ion, as described by Reactions (R1) and (R2):



The displacement of chloride from sea salt is enhanced in summer months, when compared to other months of the year<sup>7</sup>.

Acid gases in the sampled air flow are stripped from the air stream passing over the sampled particulate matter held on the filter pack by the denuder sections downstream. This limits particle aging (by reaction with atmospheric gases)<sup>15</sup> and allows for accurate determination of the chloride concentration in the sampled  $\text{PM}_x$  over long sample periods, e.g., a month. Though the concentration gases collected on the coated-glass section of the DELTA sampler were not determined, it is assumed that the acid gas, that would otherwise act to displace chloride from the sampled  $\text{PM}_x$ , break-through was minimal.

The chloride concentration can be enhanced through the emission of hydrochloric acid (HCl) gas to the atmosphere from high-temperature combustion processes such as coal burning and incineration<sup>2</sup>. HCl emissions have decreased in recent years due to the reduction in the use of coal as a fuel in power generation and flue gas abatement measures.

## 2.4 Determination the $\text{PM}_x$ sea salt mass fraction

Following ion chromatographic analysis, the mass concentration ( $\mu\text{g m}^{-3}$ ) of the chloride and sodium ion in the sampled  $\text{PM}_x$  was calculated thus:

$$\frac{\text{ion concentration (ppm)} \times \text{volume of extract solution (ml)}}{\text{volumetric sample flow rate over exposure period (m}^3\text{)}} \quad \text{Equation (1)}$$

Note: 1 ppm = 1  $\mu\text{g ml}^{-1}$ .

The monthly mean  $\text{PM}_x$  sea salt mass fraction was subsequently calculated based on the methodology outlined in Section 4.

<sup>15</sup> Jones, T. P., Williamson, B. J., Bérubé, K. A., Richards, R. J.: Microscopy and chemistry of particles collected on TEOM filters: Swansea, south Wales, 1998-1999, Atmospheric Environment, 35(21), 3573-3583, doi: 10.1016/S1352-2310(00)00570-7 2001.

### 3 Partisol sampler

The Commission guidance on demonstrating and subtracting exceedances attributable to natural sources<sup>2</sup> states that due to the episodic nature of sea salt emissions, accurate daily quantification is required in order to apply a correction to the daily mean PM<sub>10</sub> mass concentration. Accounting for the sea salt contribution to the PM<sub>10</sub> mass concentration reported in the Questionnaire also requires that the sea salt mass fraction be determined at each station reported. The number of exceedances of the daily mean PM<sub>10</sub> LV at the Rosia Road air quality monitoring station measured year-on-year has typically been above the 35 permitted by the AQD. Therefore the PM<sub>10</sub> sea salt mass fraction is only quantified and subtracted from the daily mean PM<sub>10</sub> mass concentration measurements from this station.

Daily measurements of the PM<sub>10</sub> sea salt mass fraction were made using a dedicated Thermo Scientific Partisol Plus 2025 Sequential Air Sampler installed at the Rosia Road air quality monitoring station. The sampler was installed at the site on 8<sup>th</sup> April 2011 to specifically enable assessment of the daily mean PM<sub>10</sub> sea salt mass fraction. The sampler was co-located next to the existing Partisol samplers and the DELTA sampler at the Rosia Road air quality monitoring station as shown in Figure 3.1.

**Figure 3.1** PM<sub>x</sub>, PM<sub>10</sub>, PM<sub>2.5</sub> and gas sampler inlet arrangement at the Rosia Road air quality monitoring station.

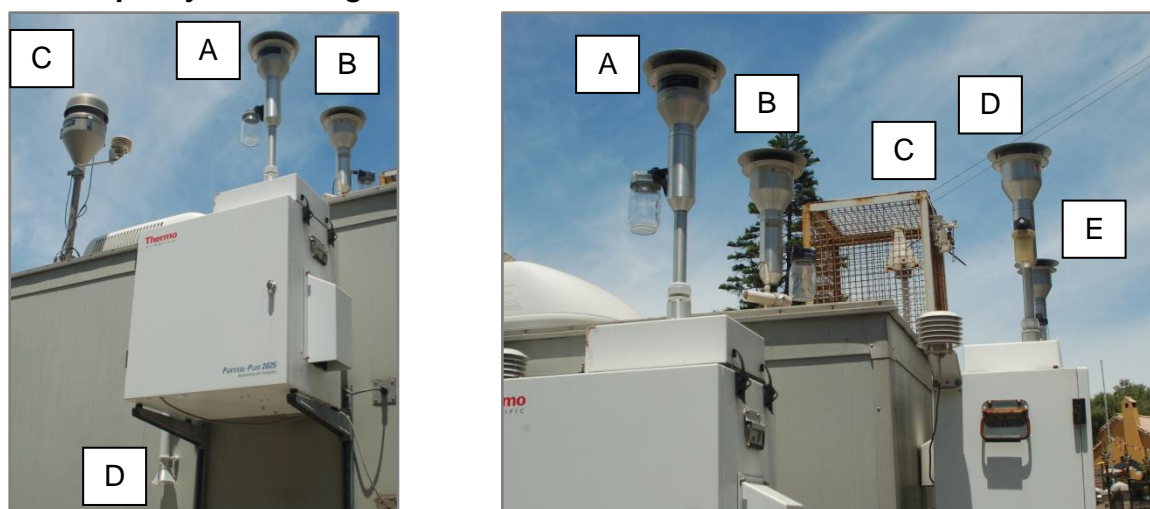

- A. PM<sub>10</sub> (sea salt) Partisol sampler inlet
- B. PM<sub>10</sub> FDMS sampler inlet
- C. PM<sub>10</sub> Digital sampler inlet
- D. PM<sub>x</sub> DELTA inlet

- A. PM<sub>10</sub> (sea salt) Partisol sampler inlet
- B. PM<sub>10</sub> FDMS sampler inlet
- C. Gas analyser inlet
- D. PM<sub>10</sub> Partisol sampler inlet
- E. PM<sub>2.5</sub> Partisol sampler inlet

PM<sub>10</sub> was sampled onto 47 mm diameter Pallflex Tissuquartz 2500QAT-UP Filters. By comparison, PM<sub>10</sub> sampled by the pre-existing Partisol sampler installed at the Rosia Road air quality station is collected onto Emfab filters, which are composed of pure borosilicate glass microfibers reinforced with woven glass cloth and bonded with PTFE. The Pallflex Tissuquartz filters were chosen due to their high chemical purity (low blank values of Cl<sup>-</sup> and Na<sup>+</sup>). This approach is used in the United Kingdom to provide a daily assessment of the mass concentration of chloride (Cl<sup>-</sup>), nitrate (NO<sub>3</sub><sup>-</sup>), and sulphate (SO<sub>4</sub><sup>2-</sup>) ions in PM<sub>10</sub> particles. As a consequence of the use of the different filter media in the two Partisol samplers, the daily mean PM<sub>10</sub> mass concentrations measured are not directly comparable.

The Tissuquartz filters were weighed pre- and post-deployment in a temperature and humidity controlled environment to allow the gravimetric mass of PM<sub>10</sub> to be accurately assessed in conformance with CEN12341 (BS EN 12341:1999, determination of the PM<sub>10</sub> fraction of suspended particulate matter: reference method and field test procedure to demonstrate reference equivalence of measurement methods). A combined laboratory/field/transport blank is used per batch of 15 filters. This filter is passed through the Partisol sampler.

Following exposure in the field, the Tissuquartz filters were returned to the laboratory. The water soluble components of the sampled particulate matter, including sea salt, were extracted from the sample filters by washing with 10 cm<sup>3</sup> deionised water. Ion chromatography is used to determine the chloride and sodium ion concentration of the extracts. The mass concentration ( $\mu\text{g m}^{-3}$ ) of the chloride and sodium ions in the sampled PM<sub>10</sub> was calculated as described in Equation (1) (see Section 2.4). The PM<sub>10</sub> sea salt mass fraction was inferred following the method outlined in Section 4. Possible sample contamination is identified by extraction and analysis of the combined blank and subtracted from the samples.

## 4 Results

### 4.1 Calculation of the monthly mean $PM_x$ and daily mean $PM_{10}$ sea salt mass fraction

Three methods are proposed<sup>2</sup> for the calculation of the monthly mean  $PM_x$  and daily mean  $PM_{10}$  sea salt mass fractions. These methods infer the  $PM_{10}$  sea salt mass fraction from the measured chloride ( $Cl^-$ ) and/or sodium ( $Na^+$ ) concentrations. The proposed European method assumes that sea salt is composed exclusively of NaCl and that all the chloride and sodium ions in the sampled  $PM_{10}$  are associated with NaCl. Therefore, according to composition of sea salt, the  $PM_x$  and  $PM_{10}$  sea salt mass fraction can be calculated thus:

$$\text{Sea salt } (\mu\text{g m}^{-3}) = \frac{100}{55} \times Cl^- = 1.8 \times Cl^-, \text{ or} \quad \text{Equation (2)}$$

$$\text{Sea salt } (\mu\text{g m}^{-3}) = \frac{100}{30.6} \times Na^+ = 3.27 \times Na^+, \text{ or} \quad \text{Equation (3)}$$

$$\text{Sea salt } (\mu\text{g m}^{-3}) = (Na^+ + Cl^-) \times 1.168. \quad \text{Equation (3)}$$

Equation (2) was used to determine the monthly mean  $PM_x$  and daily mean  $PM_{10}$  sea salt mass fraction. This is consistent with the UK approach<sup>16</sup> where a scaling factor of 1.648<sup>17</sup> is applied to infer the annual mean  $PM_{10}$  sea salt mass fraction from chloride ion measurements, for pollutant mapping purposes. The use of chloride ion was potentially subject to positive and negative artefacts, as discussed in Section 2.3. This approach was adopted as  $PM_{10}$  mass concentrations in Gibraltar were subject to enhancement due to African dust events: the horizontal transport of wind-blown dust from North Africa. One key component of wind-blown dust is sodium. Therefore the use of sodium to determine the monthly mean  $PM_x$  and daily mean  $PM_{10}$  sea salt mass fractions may have been subject to enhancement due to the presence of sodium in the sampled  $PM_x$  and  $PM_{10}$  due to wind-blown dust.

Only the daily mean  $PM_{10}$  sea salt mass fraction measurements from the Partisol sampler located at the Rosia Road air quality monitoring station are used for the natural sources correction for compliance reporting<sup>18</sup>, in accordance with the Guidance issued by the Commission<sup>2</sup>.

The contribution of natural sources (African dust and sea salt) to the daily mean  $PM_{10}$  mass concentration measured at the Rosia Road air quality monitoring station was achieved by firstly subtracting of the contribution to the daily mean  $PM_{10}$  mass concentration from African dust. Secondly, the daily mean  $PM_{10}$  sea salt mass fraction was subtracted to provide the corrected daily and annual mean  $PM_{10}$  mass concentration corrected for natural sources.

<sup>16</sup> Brookes, D.M., Stedman, J.R., Grice, S.E., Kent, A.J., Walker, H.L., Cooke, S.L., Vincent, K.J., Lingard, J.J.N., Bush, T.J., and Abbott, J. (2011). UK modelling under the Air Quality Directive (2008/50/EC) for 2010 covering the following air quality pollutants: SO<sub>2</sub>, NO<sub>x</sub>, NO<sub>2</sub>, PM<sub>10</sub>, PM<sub>2.5</sub>, lead, benzene, CO, and ozone. Report to The Department for Environment, Food and Rural Affairs, Welsh Assembly Government, the Scottish Government and the Department of the Environment for Northern Ireland, AEAT/ENV/R/3215 Issue 1. [http://uk-air.defra.gov.uk/reports/cat09/1204301513\\_AQD2010mapsrep\\_master\\_v0.pdf](http://uk-air.defra.gov.uk/reports/cat09/1204301513_AQD2010mapsrep_master_v0.pdf)

<sup>17</sup> The use of a scaling factor of 1.648 treats other alkali and alkaline metal components of sea salt (magnesium, calcium and potassium) as sodium.

<sup>18</sup> Kent, A.J. and Lingard, J.J.N. (2012). Quantification and correction of natural particulate matter in Gibraltar, 2011. [http://www.gibraltarairquality.gi/documents/Gib\\_natural\\_quantification\\_2011\\_v2.pdf](http://www.gibraltarairquality.gi/documents/Gib_natural_quantification_2011_v2.pdf)

## 4.2 2011 measurement summary

Sections 4.2.1 and 4.2.2 provide a summary of the 2010-11 DELTA and Partisol measurements, respectively.

### 4.2.1 DELTA sampler

Monthly measurements of the  $PM_x$  sea salt mass fraction commenced simultaneously on 1<sup>st</sup> September 2010 at the Rosia Road and Bleak House air quality monitoring stations. Figure 4.1 summarises the monthly mean  $PM_x$  sea salt mass fractions measured at the two air quality monitoring stations in Gibraltar from September 2010 to December 2011. The measurements, though limited to one year's results, show an increase in the  $PM_x$  sea salt mass fraction in the winter and early spring (December 2010 to March 2011). As discussed in Section 1, sea salt aerosol production is highly dependent on sea state and synoptic-scale meteorology (e.g., over a horizontal scale of 1000 km). Therefore increases in the rate of production of sea salt aerosol, and hence the monthly mean  $PM_x$  sea salt mass fraction, were expected to occur at this time of year. It should be noted that winter sanding of roads and pavements is not undertaken in Gibraltar unlike other (northern) European countries, therefore the enhancement in the monthly mean  $PM_x$  sea salt mass fraction in the winter cannot be due to this activity.

There were four months of missing measurements during the first 15 months of sampling. This was due to a faulty air pump (April and May 2011 at Bleak House) and high blank filter chloride ion concentrations/potential under sampling (August and September 2011 at Rosia Road). The sample filters are analysed a month in arrears. Therefore sampling problems in one month often transfer into the next before sampling issues become apparent and can be followed-up with the LSO.

**Figure 4.1**  $PM_x$  sea salt mass fraction ( $\mu\text{g m}^{-3}$ ) measured at Rosia Road and Bleak House from September 2010 to December 2011.

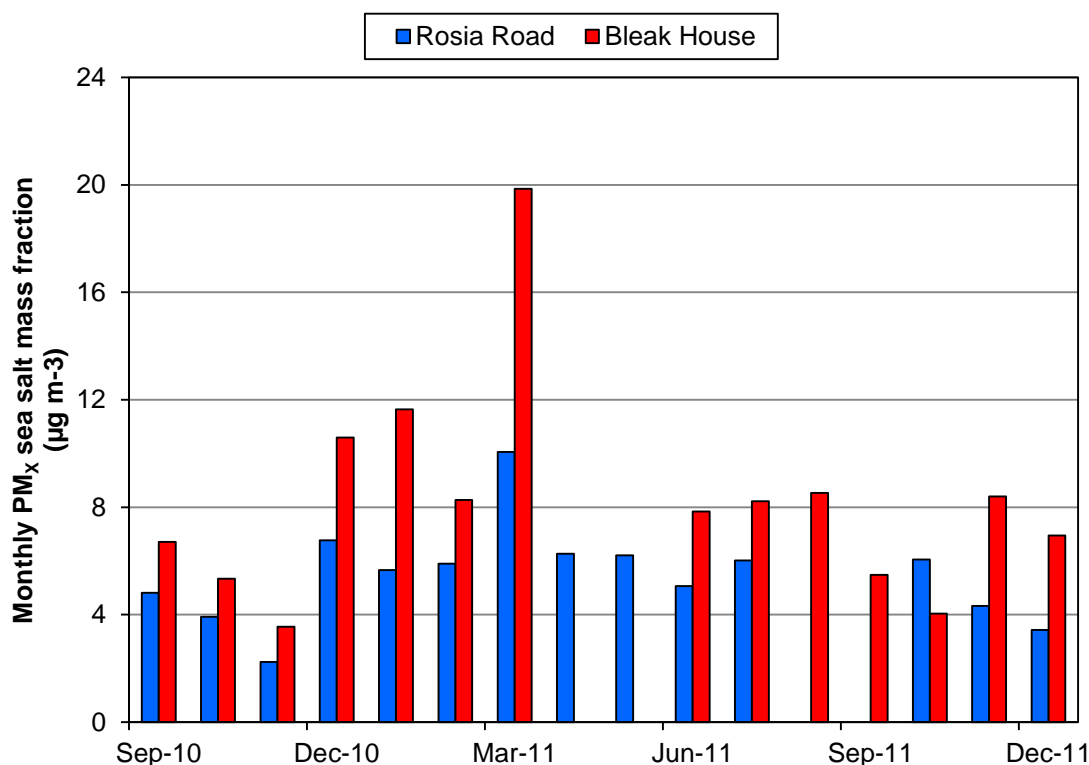

The monthly mean  $PM_x$  sea salt mass fraction ranged from 4-10  $\mu\text{g m}^{-3}$  and 4-20  $\mu\text{g m}^{-3}$  at the Rosia Road and Bleak House air quality monitoring stations, respectively. The monthly mean  $PM_x$  sea salt mass fraction at Bleak House was twice that measured at the Rosia

Road air quality monitoring station as shown in Figure 4.2. This is to be expected given the proximity, and the more exposed nature, of the air quality monitoring station at Bleak House.

**Figure 4.2 Relationship of the  $PM_x$  sea salt mass fraction ( $\mu\text{g m}^{-3}$ ) measured at Rosia Road and Bleak House from September 2010 to December 2011.**

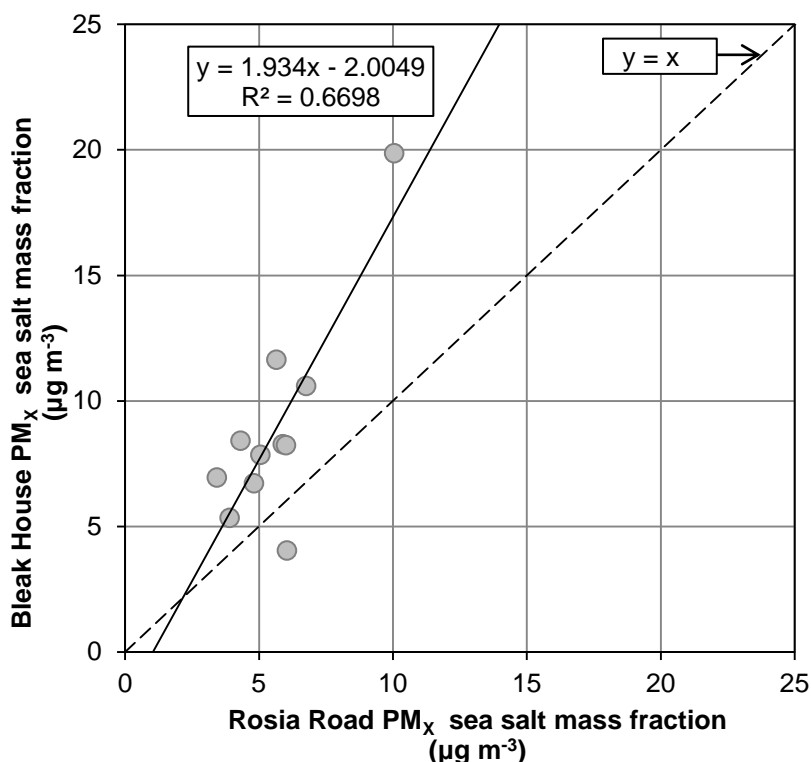

#### 4.2.2 Partisol sampler

Daily measurements of the  $PM_{10}$  sea salt mass fraction commenced on 8<sup>th</sup> April 2011 at the Rosia Road air quality monitoring station. The 2011 measurements from the dedicated sea salt (SS)  $PM_{10}$  Partisol sampler, along with those from the co-located  $PM_{10}$  Partisol sampler and FDMS are given in Figure 4.3. The plot demonstrates that there is good agreement in the daily mean  $PM_{10}$  mass concentration measured by the three  $PM_{10}$  samplers.

Figure 4.4 shows a time-series plot of the daily mean  $PM_{10}$  sea salt mass fraction measured at the Rosia Road air quality monitoring station by the sea salt  $PM_{10}$  Partisol sampler. The 2011 daily mean  $PM_{10}$  sea salt mass fraction ranged from less than 1 to  $16 \mu\text{g m}^{-3}$ . The annual mean sea salt mass concentration was  $3 \mu\text{g m}^{-3}$ . This value corresponds well previous Spanish research undertaken in La Línea de la Concepción<sup>7</sup>, which lies to the north of Gibraltar, just over the border with Spain.

Figure 4.5 shows the relationship between the daily mean wind speed measured at Gibraltar airport at reference height ( $z$ ) of 10 m ( $U_{10}$ ) and the daily mean  $PM_{10}$  sea salt mass fraction at Rosia Road. It should be noted that the natural log ( $\ln$ ) of daily mean  $PM_{10}$  sea salt mass fraction values has been taken. This enables the exponential relationship between these two parameters, as noted in Section 1, to be plotted using a simple linear plot. The  $U_{10}$  wind speed is taken to be generally representative of the free wind speed in the lower boundary layer outside of the lower portion. In the lower portion of the boundary layer vegetation, e.g., tress, grassland; natural features, e.g., hills, valleys; and, anthropogenic features, e.g., buildings, act to reduce wind speed. The plot shows that there is a high degree of variation in the daily mean  $PM_{10}$  sea salt mass fraction at Rosia Road for a given wind speed ( $U_{10}$ ). Therefore predicting the daily mean  $PM_{10}$  sea salt mass fraction using a generalized approach, i.e., one linking wind speed and the daily mean  $PM_{10}$  sea salt mass fraction, based upon the line of best-fit through the points, would not be ideal. The line of best-fit shows a positive gradient and a reasonable level of agreement exists ( $r^2 = 0.2751$ ) between the



measurements, given the total number of points plotted ( $n = 261$ ). This is to be expected as sea salt aerosol production is principally wind-driven, as discussed in Section 1.

**Figure 4.3 2011 time-series plot of the daily mean  $PM_{10}$  mass concentration measured at the Rosia Road air quality monitoring station by the FDMS, Partisol, and sea salt (SS) Partisol samplers.**

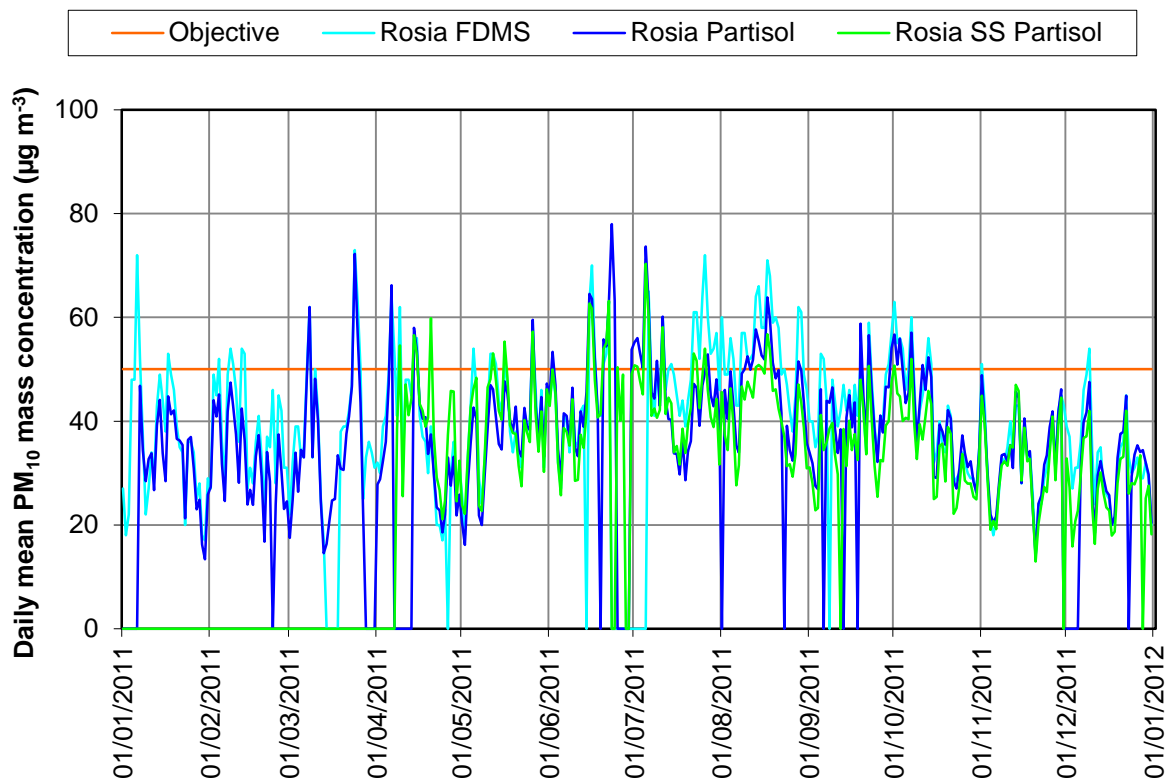

**Figure 4.4 2011 time-series plot of the daily mean  $PM_{10}$  sea salt mass fraction ( $\mu\text{g m}^{-3}$ ) measured at the Rosia Road air quality monitoring station by the sea salt (SS) Partisol sampler.**

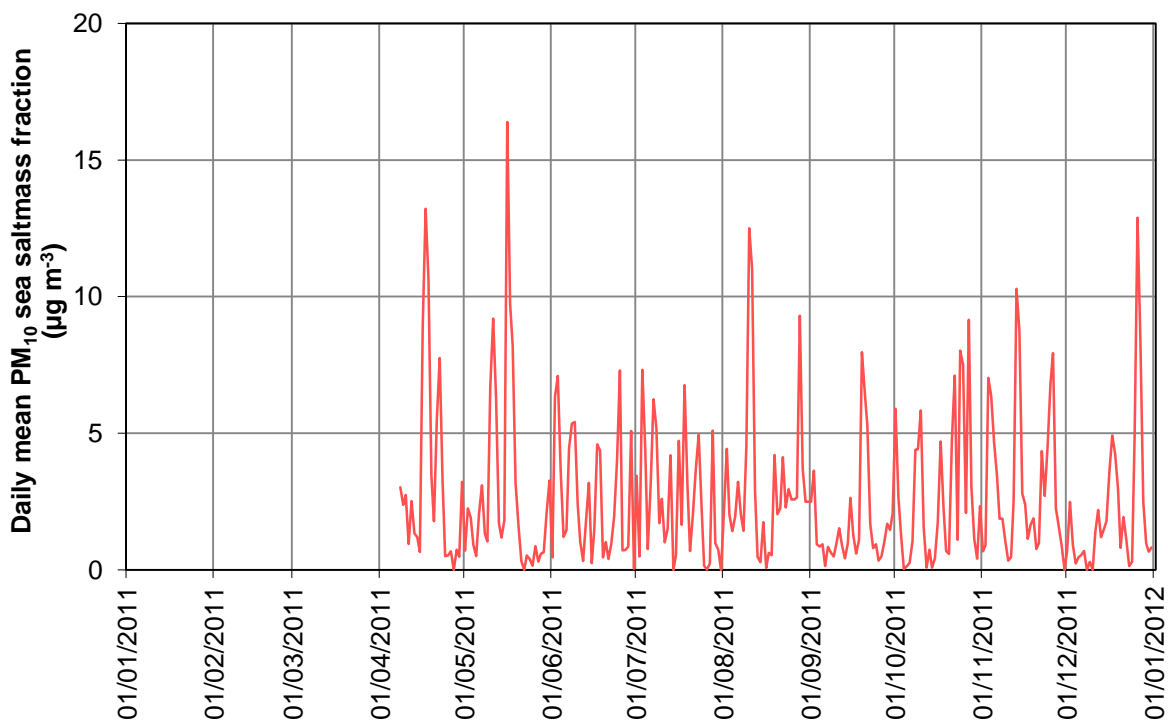

**Figure 4.5 Relationship between the daily mean wind speed ( $m s^{-1}$ ) measured at Gibraltar airport at  $z = 10 m$  ( $U_{10}$ ) and the daily mean  $PM_{10}$  sea salt mass fraction ( $\mu g m^{-3}$ ) at the Rosia Road air quality monitoring station.**

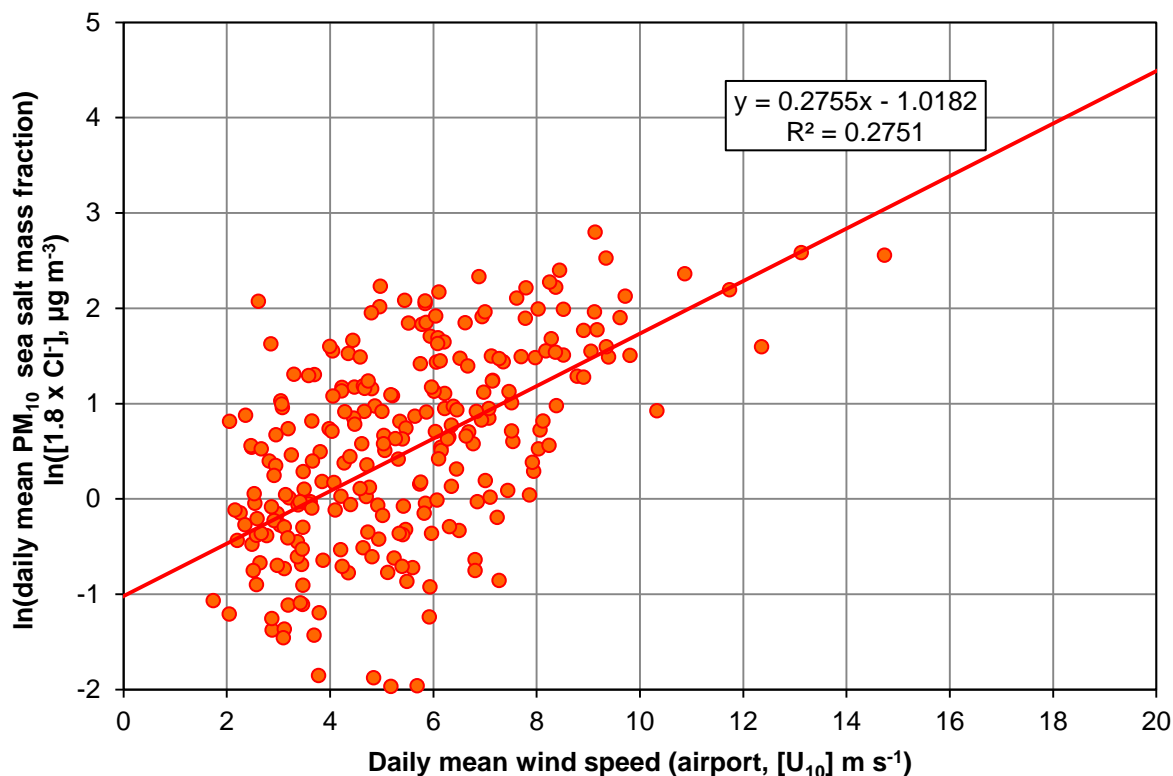

**Figure 4.6 Relationship of the monthly mean  $PM_{10}$  (Partisol sampler) and  $PM_x$  (DELTA sampler) sea salt mass fractions ( $\mu g m^{-3}$ ) measured at Rosia Road from April to December 2011.**

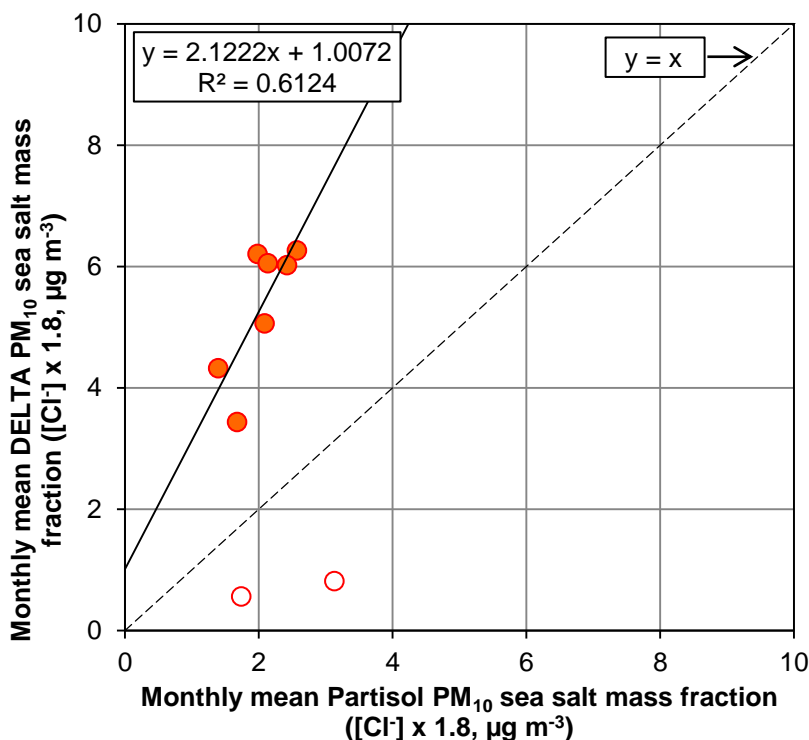

Comparison of the monthly mean  $PM_{10}$  (Partisol sampler) and  $PM_x$  (DELTA sampler) sea salt mass fractions ( $\mu g m^{-3}$ ) measured at Rosia Road from April to December 2011 are given in Figure 4.6. The measurements from the months of August and September have been

excluded from this analysis because the DELTA sampler measurements from those months were characterised by high blank filter chloride ion concentrations/potential under sampling as noted in the previous Section. The plot clearly shows the monthly mean  $PM_x$  (DELTA sampler) sea salt mass fraction to be twice that sampled by the Partisol sampler. The DELTA sampler does not have a specific particle size cut-off inlet, therefore this observation was possibly due to the sampling of airborne (sea salt) particles with a mass median aerodynamic diameter greater than  $10\ \mu\text{m}$ . If the DELTA monthly  $PM_x$  sea salt mass fraction measurements to be used as a proxy measure of the monthly mean  $PM_{10}$  sea salt mass fraction at the Rosia Road air quality monitoring station for compliance reporting, they would require correcting for this effect.







The Gemini Building  
Fermi Avenue  
Harwell  
Didcot  
Oxfordshire  
OX11 0QR

Tel: 0870 190 6756  
Fax: 0870 190 4850

[www.aeat.co.uk](http://www.aeat.co.uk)